

TEXAS DEPARTMENT OF INSURANCE

Engineering Services / MC 103-3A 333 Guadalupe Street P.O. Box 149104 Austin, Texas 78714-9104
Phone No. (512) 322-2212 Fax No. (512) 463-6693

PRODUCT EVALUATION RC-98

Effective July 1, 2003

*The following product has been evaluated for compliance with the wind loads specified in **International Residential Code (IRC)** and the **International Building Code (IBC)**. This product shall be subject to reevaluation 3 years after the effective date.*

This product evaluation is not an endorsement of this product or a recommendation that this product be used. The Texas Department of Insurance has not authorized the use of any information contained in the product evaluation for advertising, or other commercial or promotional purpose.

This product evaluation is intended for use by those individuals who are following the design wind load criteria in Chapter 3 of the IRC and Section 1609 of the IBC. The design loads determined for the building or structure shall not exceed the design load rating specified for the products shown in the limitations section of this product evaluation. This product evaluation does not relieve a Texas licensed engineer of his responsibilities as outlined in the Texas Insurance Code, the Texas Administrative Code, and the Texas Engineering Practice Act.

5V Crimp (26 gauge) manufactured by

Building Components, Inc.
11919 North Garden
Houston, Texas 77071
Telephone: (281) 261-1224

is acceptable in designated catastrophe areas along the Texas Gulf Coast when installed in accordance with the manufacturer's installation instructions and this product evaluation.

PRODUCT DESCRIPTION

The 5V Crimp roof panels are standard 26 gauge thickness, 80,000 psi full hard steel with either a G-90 Galvanized or Galvalume substrate. In accordance with this product evaluation report, the panels shall be secured to a $1\frac{5}{32}$ " wood structural panel deck.

LIMITATIONS

Design Wind Pressures: Design wind pressure limitations are specified in Table 1.

Roof Deck Attachment: The roof deck shall be secured to the roof framing to resist the required design pressures.

Installation Over an Existing Roof Covering: Installation over an existing roof covering is limited to a maximum of one existing layer of composition shingles, wood shingles or shakes, built-up roofing, or roll roofing. If the roof panels are attached directly to the roof deck, then the existing roof deck shall not be less than nominal $1\frac{5}{32}$ inch wood structural panels. Note: Inspection of the existing roof deck must be made before installing the roof panels. The condition of the existing roof deck must be acceptable to receive the roof panels before the roof panel installation can proceed.

Roof Slope: The 5V Crimp roof panels shall not be installed on roofs with a roof slope less than 3:12.

INSTALLATION INSTRUCTIONS

General Installation Requirements:

The installation of the panels shall be limited to extending two inches beyond the plane of the fascia board.

Panel Installation Requirements

Panels: Panels shall be attached in accordance with Table 1. Refer to Figures 1 and 2 for installation details.

Table 1

Attachment of 26 gauge 5V-Crimp Roof Panel to nominal $\frac{15}{32}$ inch wood structural panel roof decking:

Design Wind Pressure (psf)	Attachment of Panel Clip to $\frac{15}{32}$ " thick wood structural panel deck
-55	(1) #14-1" HWH Type 17 Sealer @ 4'-0" o.c.
-75	(1) #14-1" HWH Type 17 Sealer @ 2'-0" o.c.

Underlayment: A minimum of one layer of No. 30 (Type II) asphalt felt shall be used. The underlayment used shall comply with one or more of the following: ASTM D 226, ASTM D 4869, or ASTM D 1970. The felt shall be installed with 6 inch side laps and 3 inch end laps. The felt shall be fastened to the roof deck with corrosion resistant fasteners in accordance with the manufacturer's installation instructions. Fasteners are to be applied along the overlap not farther apart than 36 inches on center.

Anchorage:

To Roof Decking: The panels shall be fastened in accordance with Table 1 with (1) #14 x 1 inch HWH Type 17 sealer, manufactured by Sealite Building Fasteners. If the panels are laid directly over an existing roof covering, then (1) #14 x 2 inch HWH Type 17 Pancake Head screws are required. The fasteners shall be long enough to penetrate completely through the wood structural panels with a minimum exposure of $\frac{1}{4}$ inch below the underside of the wood structural panels.

Ridge Cap and Rake Trim: The ridge cap and the rake trim shall be attached to the panels with #14 x $\frac{7}{8}$ inch HWH self-drilling lap screws as indicated in Figure 1 and Figure 2.

Alternative Fasteners: Substitution of equivalent fasteners shall meet the following requirements:

#14 x 1" HWH Type 17 Sealer screws, manufactured by Sealite Building Fasteners.
Ultimate withdrawal (pullout) \geq 418 lbs. in $\frac{15}{32}$ inch wood structural panels

Note: The manufacturer's installation instructions shall be on the job site during the installation. All fasteners shall be corrosion resistant as specified in the International Residential Code (IRC) and the International Building Code (IBC).

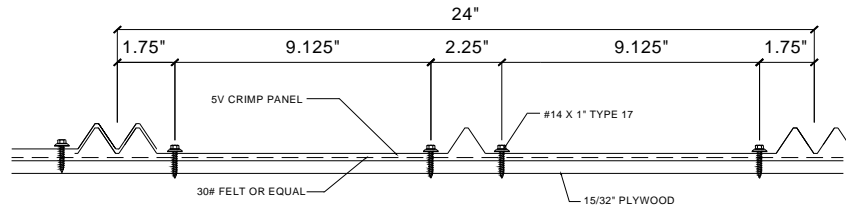

FASTENER LOCATION

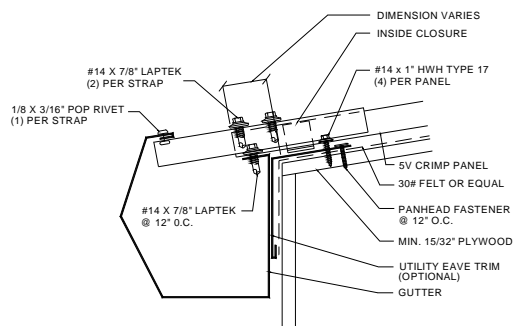

STANDARD LOW EAVE DETAIL WITH GUTTER

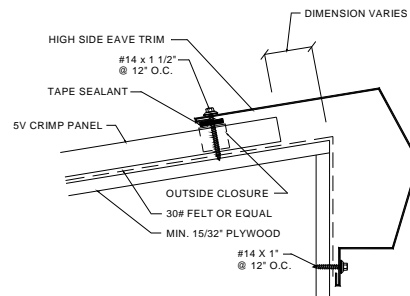

STANDARD DETAIL AT HIGH EAVE

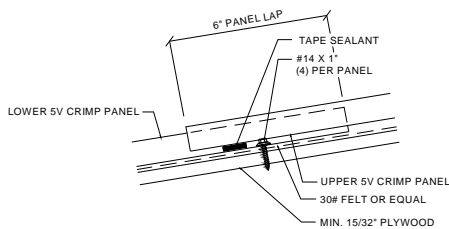

STANDARD DETAIL AT PANEL ENDLAP

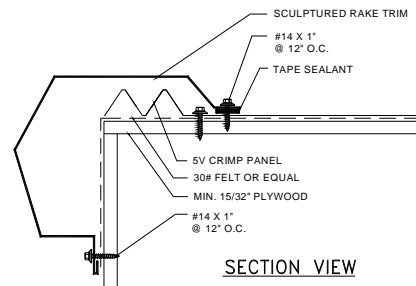

SECTION VIEW
 STANDARD DETAIL AT RAKE

Figure 1: 5V Crimp Panel Details

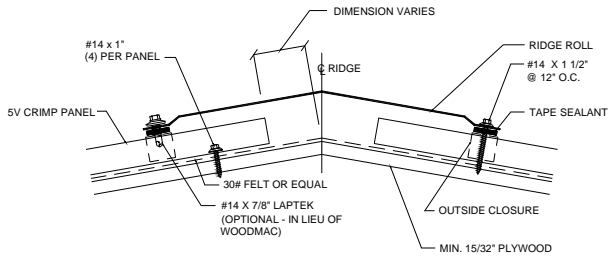

STANDARD DETAIL AT RIDGE

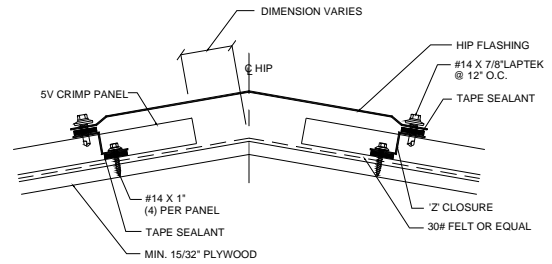

STANDARD DETAIL AT HIP

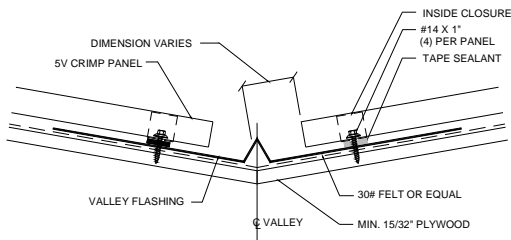

STANDARD DETAIL AT VALLEY

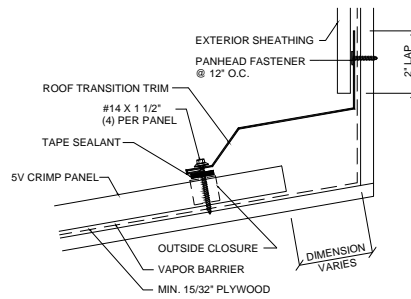

STANDARD DETAIL AT ROOF TRANSITION

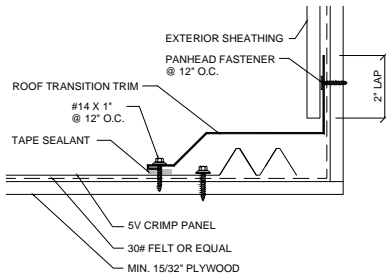

STANDARD DETAIL AT HIGH / LOW

Figure 2: 5V Crimp Panel Details